

DS Double Shell Corrugated Hose

Standard model stainless steel corrugated hose in double shell construction, braided or unbraided for pressured applications with the possibility to heat or cool the inner hose media/fluid.

Available with various standard and non-standard couplings at any length required. Couplings are available in carbon steel, stainless steel, brass or cast iron.

For detailed technical specifications on DS double-shell stainless steel corrugated hoses please check the following table and documents or [contact us](#).

▶ Features

- ✓ stainless steel flexible hose
- ✓ double-shell hose
- ✓ various couplings available
- ✓ fully customizable item



Note | Type DS - Double Shell Hose | 3D view

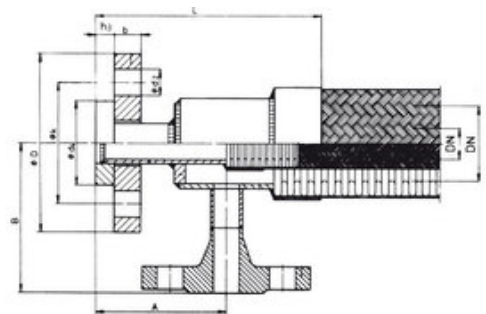

Note | Type DS - Double Shell Hose | dimensional sketch

▶ Technical Specifications

DN *	[mm] [inch]	SE111-base			SE112-base		
		Nominal (PN) [bar]	Dynamic Bend Radius [mm]	Approx. Weight [g/m]	Nominal (PN) [bar]	Dynamic Bend Radius [mm]	Approx. Weight [g/m]
20	3/4"	40	200	540	65	220	910
25	1"	40	220	800	65	245	1410
32	1 1/4"	25	270	1000	50	300	1700
40	1 1/2"	25	300	1250	50	330	2180
50	2"	25	350	1650	40	385	2640
65	2 1/2"	20	410	2380	25	450	4090
80	3"	16	450	2600	25	500	4210
100	4"	16	560	3450	25	620	5500
125	5"	10	660	5800	20	730	9480
150	6"	10	815	8200	16	900	11120
200	8"	6	1015	11500	10	1120	16270
250	10"	6	1200	17250	10	1320	23470

* other sizes available on individual request.

▶ Couplings Types

▶ Flanged Couplings

▶ Coupling AE201

Collar and swivel flange assembly for stainless steel corrugated hose type SE110.

Available in carbon steel and stainless steel. Flanges according to DIN , ANSI , other known standards or custom design.

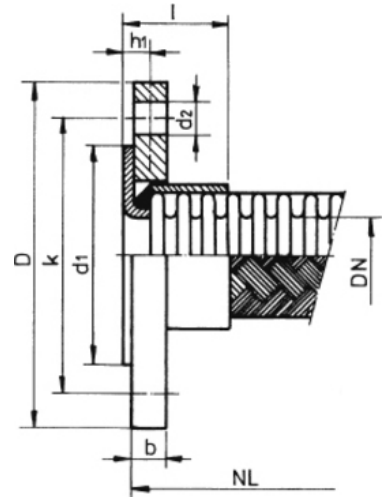
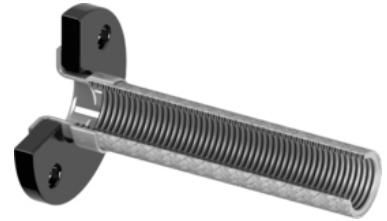

DN [mm]	l [mm]	h1 [mm]
10	29	9
15	29	9
20	32	12
25	40	20
32	40	20
40	40	20
50	40	20
65	40	20
80	50	25
100	50	25
125	60	30
150	70	30

* Acc. to DIN EN 1092 type 02 + 33 in PN10

** for other DN and D, k, d1, d2, b measurements please check Standard's Page or Catalog Appendix.

► Coupling AE202

Weld-on shoulder and floating flange coupling assembly for stainless steel corrugated hose type SE110.

Available in carbon steel and stainless steel. Flanges according to DIN , ANSI , other known standards or custom design.

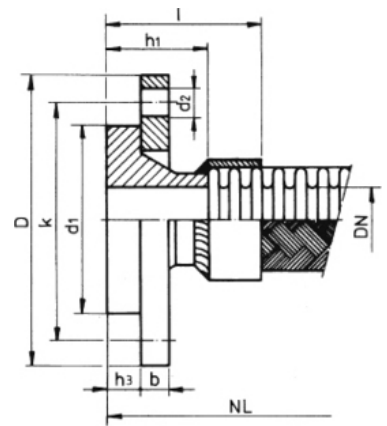
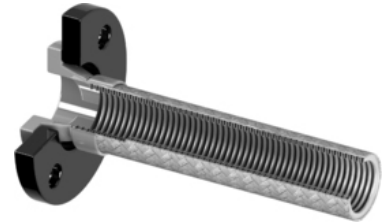

DN [mm]	l [mm]	h1 [mm]	h3 [mm]
10	55	35	12
15	55	38	12
20	60	40	14
25	60	40	14
32	60	42	14
40	60	45	14
50	65	45	16
65	65	45	16
80	75	50	16
100	75	52	18
125	80	55	18
150	90	55	20

* Acc. to DIN EN 1092 type 04 + 34 in PN10-PN16

** for other DN and D, k, d1, d2, b measurements please check Standard's Page or Catalog Appendix.

► Coupling AE203

Collar sockets and swivel flange assembly for stainless steel corrugated hose type SE110.

Available in carbon steel and stainless steel. Flanges according to DIN , ANSI , other known standards or custom design.

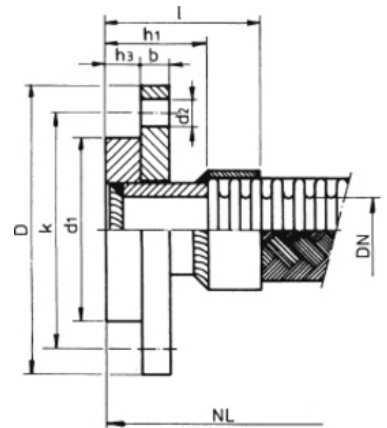

DN [mm]	l [mm]	h1 [mm]	h3 [mm]
10	75	55	12
15	75	55	12
20	80	60	14
25	85	65	14
32	90	70	14
40	95	75	14
50	95	75	16
65	100	80	16
80	110	85	16
100	115	90	16
125	120	90	18
150	135	95	20

* Acc. to DIN EN 1092 type 02 + 32 in PN10-PN16

** for other DN and D, k, d1, d2, b measurements please check Standard's Page or Catalog Appendix.

► Coupling AE204

Weld-on (fixed) flange coupling assembly for stainless steel corrugated hose type SE110.

Available in carbon steel and stainless steel. Flanges according to DIN , ANSI , other known standards or custom design.

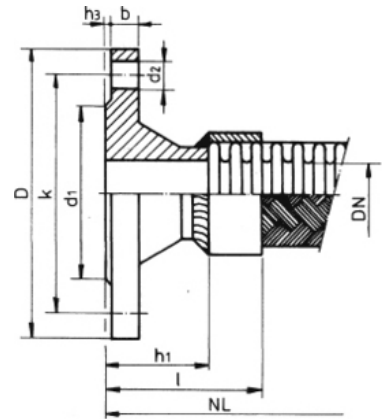
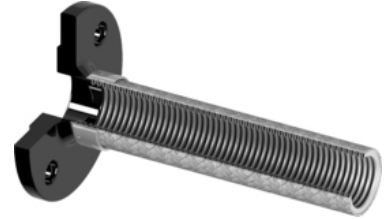

DN [mm]	l [mm]	h1 [mm]
10	55	35
15	55	38
20	58	40
25	58	40
32	60	42
40	62	45
50	65	45
65	65	45
80	75	50
100	77	52
125	85	55
150	95	55

* Acc. to DIN EN 1092 type 11 in PN10-PN16

** for other DN and D, k, d1, d2, b measurements please check Standard's Page or Catalog Appendix.

► Pipe / Welding-ends Couplings

► Coupling AE301

Welding-end coupling assembly for stainless steel corrugated hose type SE110.

Available in carbon steel and stainless steel. Sizes acc. to standards or mechanized to custom specifications.

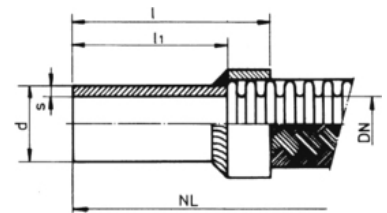

DN [mm]	d [mm]	s [mm]	l [mm]	l1 [mm]
6	8	1	70	50
10	13.5	1.8 *	70	50
12	17.2	1.8 *	70	50
15	21.3	2	70	50
20	26.9	2.6	75	55
25	33.7	2.6	80	60
32	42.4	2.6	85	65
40	48.3	2.6	90	70
50	60.3	2.9	90	70
65	76.1	2.9	95	75
80	88.9	3.2	105	80
100	114.3	3.6	110	85
125	139.7	4	115	85
150	168.3	4,5 **	130	90
200	219.1	6.3 **	140	100
250	273.0	6.3 **	140	100
300	323.9	7,1 **	140	100

* 1.6mm for stainless steel

** 4.0mm for stainless steel

*** other pipe diameters, thickness or length on request

► Coupling AE302

Tubular fitting for pipe coupling with cutting and locking ring assembly for SE110 hose.

Available in carbon steel and stainless steel. Sizes acc. to standards or mechanized to custom specifications.

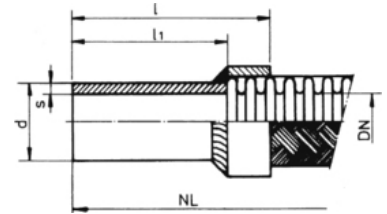

DN [mm]	d [mm]	s [mm]	l [mm]	l1 [mm]
6	8	1	48	28
8	10	1	50	30
10	12	1.5	50	30
12	15	1.5	52	32
15	18	1.5	52	32
20	22	1.5	56	36
25	28	1.5	60	40
32	35	2	65	45
40	42	2	65	45

* other pipe diameters, thickness or length on request

► Cone Seal Threaded Couplings

► Coupling AE401

Internal thread with 24 degree cone seal assembly for stainless steel corrugated hose type SE110.

Available in carbon steel and stainless steel. Sizes acc. to standards or mechanized to custom specifications.

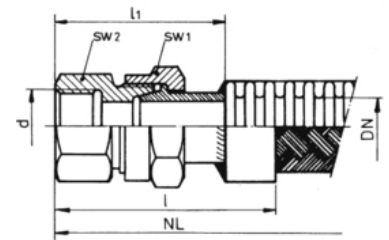

DN [mm]	d DIN2999	l [mm]	l1 [mm]	SW1 [mm]	SW2 [mm]
6	1/4"	65	45	19	19
10	3/8"	68	48	22	22
12	1/2"	75	32	27	32
15	1/2"	75	55	32	27
20	3/4"	82	62	36	32
25	1"	87	67	41	41
32	1 1/4"	93	73	50	46
40	1 1/2"	97	77	60	55
50	2"	105	85	70	65

* other thread connection, i.e. metric, NPT, cylindrical available on request

► Coupling AE403

External thread with 24 degree cone seal assembly for stainless steel corrugated hose type SE110.

Available in carbon steel and stainless steel. Sizes acc. to standards or mechanized to custom specifications.

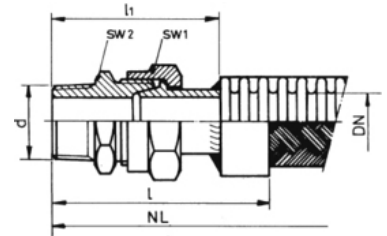

DN [mm]	d DIN2999	l [mm]	l1 [mm]	SW1 [mm]	SW2 [mm]
6	1/4"	70	50	19	17
10	3/8"	73	53	22	19
12	1/2"	82	62	32	27
15	1/2"	82	62	32	27
20	3/4"	90	70	36	32
25	1"	95	75	41	41
32	1 1/4"	101	81	50	46
40	1 1/2"	107	87	60	55
50	2"	113	93	70	65

* other thread connection, i.e. metric, NPT, cylindrical available on request

► Coupling AE404

Welding-end with 24 degree cone seal assembly for stainless steel corrugated hose type SE110.

Available in carbon steel and stainless steel. Sizes acc. to standards or mechanized to custom specifications.

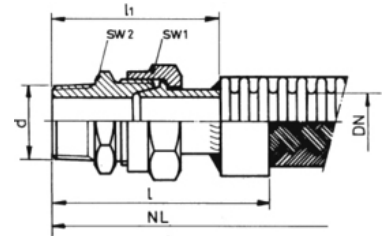

DN [mm]	d x s [mm]	l [mm]	l1 [mm]	SW1 [mm]	SW2 [mm]
6	8x1	70	50	19	17
10	13.5x1.8*	73	53	22	19
12	17.2x1.8*	82	62	32	27
15	21.3x2	82	62	32	27
20	26.9x2.6	90	70	36	32
25	33.7x2.6	95	75	41	41
32	42.4x2.6	101	81	50	46
40	48.3x2.6	107	87	60	55
50	60.3x2.9	113	93	70	65

* 1.6mm for stainless steel

** other lengths available on request

▶ Hex Nipple / Socket

▶ Coupling AE405

Hexagon nipple and tapered external thread assembly for stainless steel corrugated hose type SE110.

Available in carbon steel and stainless steel. Sizes acc. to standards or mechanized to custom specifications.

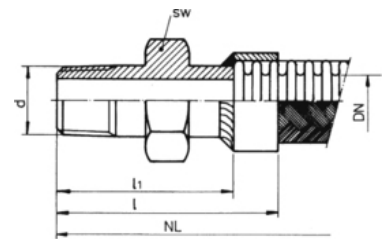

DN [mm]	d DIN2999	l [mm]	l1 [mm]	SW [mm]
6	1/4"	45	25	17
10	3/8"	48	28	19
12	1/2"	51	31	22
15	1/2"	51	31	22
20	3/4"	52	32	27
25	1"	60	40	36
32	1 1/4"	63	43	46
40	1 1/2"	66	46	50
50	2"	70	50	60
65	2 1/2"	80	60	80
80	3"	100	75	95

* for complete thread specifications please check our Standard's Page of Catalog Appendix

► Coupling AE406

Hexagon nipple and cylindrical external thread assembly for stainless steel corrugated hose type SE110.

Available in carbon steel and stainless steel. Sizes acc. to standards or mechanized to custom specifications.

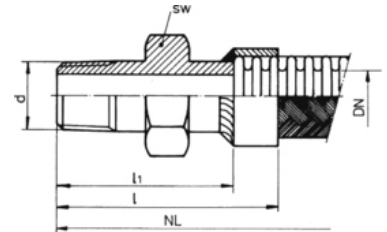

DN [mm]	d ISO228	l [mm]	l1 [mm]	SW [mm]
6	1/4"	45	25	17
10	3/8"	48	28	19
12	1/2"	51	31	22
15	1/2"	51	31	22
20	3/4"	52	32	27
25	1"	60	40	36
32	1 1/4"	63	43	46
40	1 1/2"	66	46	50
50	2"	70	50	60
65	2 1/2"	80	60	80
80	3"	100	75	95

* for complete thread specifications please check our Standard's Page of Catalog Apppendix

► Coupling AE408

Socket with internal thread assembly for stainless steel corrugated hose type SE110.

Available in carbon steel and stainless steel. Sizes acc. to standards or mechanized to custom specifications.

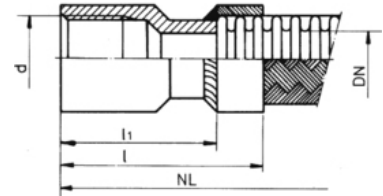

DN [mm]	d DIN2999	l [mm]	l1 [mm]
6	1/4"	45	25
10	3/8"	46	26
12	1/2"	54	34
15	1/2"	54	34
20	3/4"	56	36
25	1"	63	43
32	1 1/4"	68	48
40	1 1/2"	68	48
50	2"	76	56
65	2 1/2"	85	65
80	3"	96	71

* for complete thread specifications please check our Standard's Page of Catalog Appendix

▶ Holander Assembly

▶ Coupling AE501

Internal thread with cone seal assembly for stainless steel corrugated hose type SE110.

Available in malleable cast iron, carbon steel and stainless steel. Sizes acc. to standards or mechanized to custom specifications.



DN [mm]	d DIN2999	l [mm]	l1 [mm]	SW1 [mm]	SW2 [mm]
6	1/4"	65	45	28	18
10	3/8"	67	47	32	22
12	1/2"	74	54	39	26
15	1/2"	74	54	39	26
20	3/4"	79	59	48	31
25	1"	84	64	54	38
32	1 1/4"	87	67	67	48
40	1 1/2"	91	71	73	54
50	2"	102	82	90	66

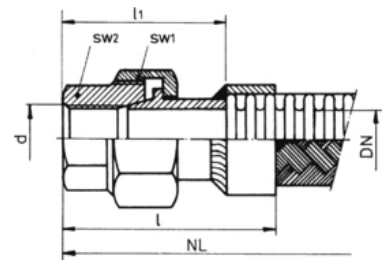

* other thread connection, i.e. metric, NPT, cylindrical available on request

** for complete thread specifications please check our Standard's Page of Catalog Appendix

► Coupling AE502

Internal thread with flat seal assembly for stainless steel corrugated hose type SE110.

Available in malleable cast iron, carbon steel and stainless steel. Sizes acc. to standards or mechanized to custom specifications.

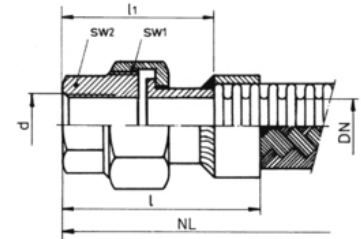

DN [mm]	d DIN2999	l [mm]	l1 [mm]	SW1 [mm]	SW2 [mm]
6	1/4"	65	45	28	18
10	3/8"	67	47	32	22
12	1/2"	74	54	39	26
15	1/2"	74	54	39	26
20	3/4"	79	59	48	31
25	1"	84	64	54	38
32	1 1/4"	87	67	67	48
40	1 1/2"	91	71	73	54
50	2"	102	82	90	66

* other thread connection, i.e. metric, NPT, cylindrical available on request

** for complete thread specifications please check our Standard's Page of Catalog Appendix

► Coupling AE503

External thread with cone seal assembly for stainless steel corrugated hose type SE110.

Available in malleable cast iron, carbon steel and stainless steel. Sizes acc. to standards or mechanized to custom specifications.

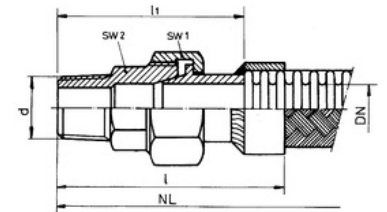

DN [mm]	d DIN2999	l [mm]	l1 [mm]	SW1 [mm]	SW2 [mm]
6	1/4"	78	58	28	18
10	3/8"	83	63	32	22
12	1/2"	93	73	39	26
15	1/2"	93	73	39	26
20	3/4"	101	81	48	31
25	1"	107	87	54	38
32	1 1/4"	111	91	67	48
40	1 1/2"	117	97	73	54
50	2"	131	111	90	66

* other thread connection, i.e. metric, NPT, cylindrical available on request

** for complete thread specifications please check our Standard's Page of Catalog Appendix

► Coupling AE504

External thread with flat seal assembly for stainless steel corrugated hose type SE110.

Available in malleable cast iron, carbon steel and stainless steel. Sizes acc. to standards or mechanized to custom specifications.

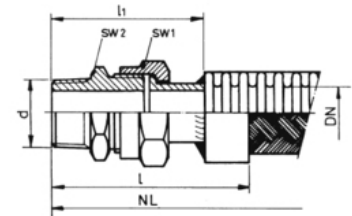

DN [mm]	d DIN2999	l [mm]	l1 [mm]	SW1 [mm]	SW2 [mm]
6	1/4"	78	58	28	18
10	3/8"	83	63	32	22
12	1/2"	93	73	39	26
15	1/2"	93	73	39	26
20	3/4"	101	81	48	31
25	1"	107	87	54	38
32	1 1/4"	111	91	67	48
40	1 1/2"	117	97	73	54
50	2"	131	111	90	66

* other thread connection, i.e. metric, NPT, cylindrical available on request

** for complete thread specifications please check our Standard's Page of Catalog Appendix

► Coupling AE505

Pipe / Weld-end coupling with cone seal assembly for stainless steel corrugated hose type SE110.

Available in carbon steel and stainless steel. Sizes acc. to standards or mechanized to custom specifications.

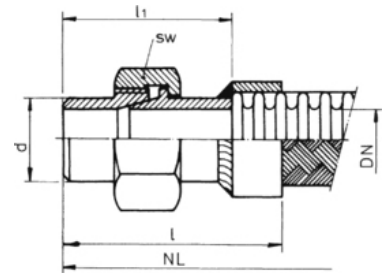

DN [mm]	d [mm]	l [mm]	l1 [mm]	SW [mm]
10	13.5	62	42	27
12	17.2	65	45	27
15	21.3	74	54	32
20	26.9	80	60	41
25	33.7	87	67	50
32	42.4	95	75	60
40	48.3	101	81	70
50	60.3	114	94	85
65	76.1	122	102	100
80	88.9	132	107	120

* other pipe sizes and lengths available on request

► Coupling AE506

Pipe / Weld-end coupling with flat seal assembly for stainless steel corrugated hose type SE110.

Available in carbon steel and stainless steel. Sizes acc. to standards or mechanized to custom specifications.

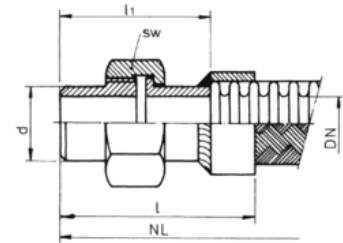

DN [mm]	d [mm]	l [mm]	l1 [mm]	SW [mm]
10	13.5	62	42	27
12	17.2	65	45	27
15	21.3	74	54	32
20	26.9	80	60	41
25	33.7	87	67	50
32	42.4	95	75	60
40	48.3	101	81	70
50	60.3	114	94	85
65	76.1	122	102	100
80	88.9	132	107	120

* other pipe sizes and lengths available on request

► Coupling AE507

Swivel nut with internal thread and spherical seal assembly for stainless steel corrugated hose type SE110.

Available in carbon steel and stainless steel. Sizes acc. to standards or mechanized to custom specifications.



DN [mm]	DIN2999		ISO228		l [mm]	l1 [mm]
	d	SW	d	SW		
6	1/4"	17	14x1.5	17	44	24
8	3/8"	20	16x1.5	19	44	24
10	1/2"	24	18x1.5	22	45	25
12	5/8"	27	22x1.5	27	48	28
15	3/4"	32	26x1.5	32	49	29
20	1"	41	30x2	36	50	30
25	1 1/4"	50	36x2	41	55	35
32	1 1/2"	55	45x2	50	55	35
40	2"	65	52x2	60	55	35
50	2 1/2"	75	-	-	65	45

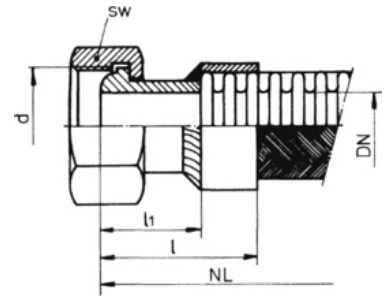

* other thread connection, i.e. metric, NPT, cylindrical available on request

** for complete thread specifications please check our Standard's Page of Catalog Appendix

► Coupling AE508

Swivel nut with internal thread and flat seal assembly for stainless steel corrugated hose type SE110.

Available in carbon steel and stainless steel. Sizes acc. to standards or mechanized to custom specifications.



DN [mm]	DIN2999		ISO228		l [mm]	l1 [mm]
	d	SW	d	SW		
6	1/4"	17	14x1.5	17	44	24
8	3/8"	20	16x1.5	19	44	24
10	1/2"	24	18x1.5	22	45	25
12	5/8"	27	22x1.5	27	48	28
15	3/4"	32	26x1.5	32	49	29
20	1"	41	30x2	36	50	30
25	1 1/4"	50	36x2	41	55	35
32	1 1/2"	55	45x2	50	55	35
40	2"	65	52x2	60	55	35
50	2 1/2"	75	-	-	65	45

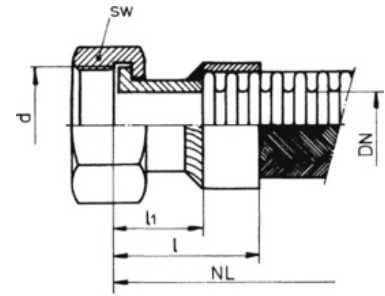

* other thread connection, i.e. metric, NPT, cylindrical available on request

** for complete thread specifications please check our Standard's Page of Catalog Appendix